

FlexTemp Iso Universal Transmitter

Input: RTD, T/C, mV, and Resistance sensors

Output: 4...20 mA, opto relay and LCD bar graph with zoom feature

Isolation voltage 2 kV_{ac/dc}

2-way configuration (Windows)

Accuracy < 0.1°C (Pt100)

Configurable linearisation, damping and status indication

PC signal monitoring

Demko EEx ia IIC T5, ATEX II 1G



Description

FlexTemp Iso is a 4...20 mA (20...4 mA) loop-powered universal transmitter with galvanic isolation between input, output and relay.

FlexTemp Iso has a millivolt input for T/C sensors and a resistance input for RTD sensors. Thus it can be used also for linear resistance, current and voltage measurements.

2, 3 or 4-wire connection can be selected for the resistance input.

Local, remote or fixed CJC-compensation can be configured.

Using a PC, the Windows based Flex-program and a FlexProgrammer, the following parameters can be configured via the 2-way communication on the signal cable: TAG-no., input type, number of wires, CJC-compensation, measuring range, damping, 30-point linearisation table, error indications and relay output.

FlexTemp Iso can be used for cable resistance measurement.

FlexTemp Iso with relay output is ideal as local temperature controller with display and alarm capability. Furthermore, the output signal can be sent to a PLC for remote monitoring.



Technical Data

Input

Digital accuracy	See „Measuring ranges“
CJC-compensation {1}	Local < 0.5°C Remote < 0.2°C
RTD measuring current	0.2 mA, continuously
Cable resistance (3-/4-wire)	T > 600°C: Max. 10 Ohm/wire {1} T < 600°C: Max. 30 Ohm/wire {1}
Protection	+/- 35 V _{dc}
Suppression	50 and 60 Hz
Resolution	16 bit
Repeatability	< 0.05°C

Output

Signal span	4...20 mA, 2-wire {1} 20...4 mA, 2-wire {1}
Accuracy	< 0.1% of signal span
Supply range	6.5...35 V _{dc}
Ripple immunity	3 V _{rms}
Load equation	$R_L \leq (V_{cc} - 6.5)/23$ [kOhm]
Up/Down scaling	23 mA/3.5 mA {1}
Sensor-break indication	23 mA/3.5 mA {1}
Damping	0...30 sec. {1}
Response time (t ₉₀)	Pt100 1.0 sec. ; T/C 1.6 sec.
Resolution	12 bit

Environmental conditions

Operating temperature, std.	-10...70°C
Relay version	-10...50°C
Storage temperature	-35...85°C
Humidity	< 90% RH, non condensing
Vibrations	Lloyds Register, test 2

EMC data

Immunity	EN 50082-2
Emission	EN 50081-2

Approval (Demko) EEx ia IIC T5, ATEX II 1G

Supply	6.5...28 V _{dc}
Internal inductivity	$L_i \leq 15 \mu\text{H}$
Internal capacity	$C_i \leq 1 \text{ nF}$
Barrier data	$U \leq 28 \text{ V}_{dc}$; $I \leq 0.1 \text{ A}$; $P \leq 0.7 \text{ W}$
Temperature class	T1...T5: -10 < T _{amb} < 70°C

Mechanical data

Dimensions	62 x 88 x 24 mm
Protection class	Housing: IP 30 Terminals: IP 10
DIN-rail mounting	DIN 46277

Other data

Isolation	2 kV _{ac/dc}
Temperature drift	Typ. 0.003% per °C Max. 0.01% per °C
Power-on time	1.8...3.9 sec.
Display	LCD bar graph, 51 segments Resolution 1%
Approval	Det Norske Veritas

Relay

Voltage	Max. 230 V _{ac} ; max. 50 V _{dc}
Current	Max. 50 mA (cont.) Max. 500 mA (pulse)
Relay function {1}	Set/Reset

Test conditions

Configuration	Pt100; 0...100°C
Amb. temperature	23°C +/- 2°C

Disposal of product and packing

According to national laws or by returning to Bourdon-Haenni

Note

{1} Configurable

Examples of Application

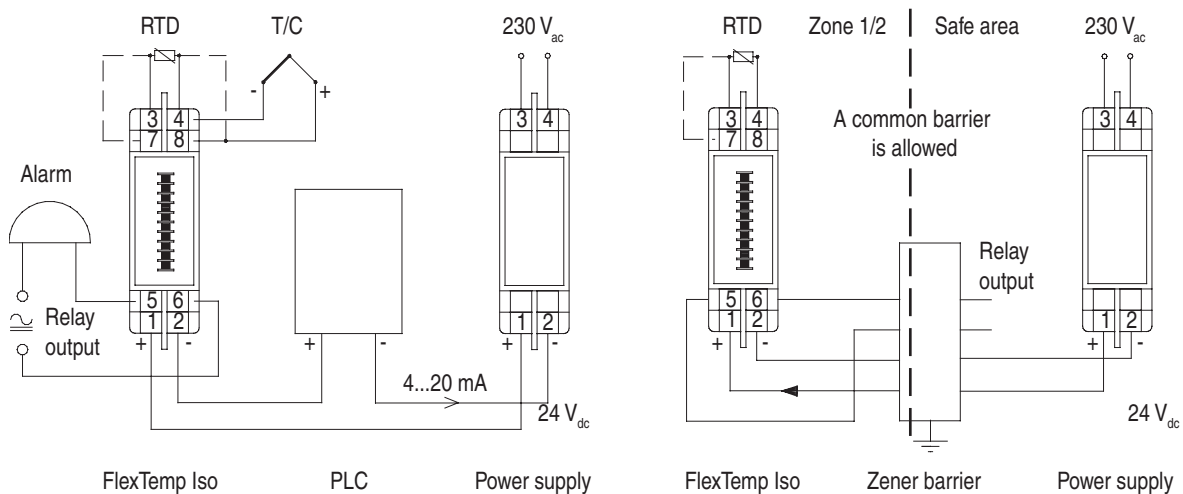

Measuring Ranges

Type	Standard	Range	Min. span	Accuracy	Resolution
Pt25...Pt1000	DIN/EN/IEC 60751	-200...850°C {2}	10°C	0.1°C	0.1°C
Pt25...Pt1000	a = 0.003902	-200...850°C {2}	10°C	0.1°C	0.1°C
Pt25...Pt1000	a = 0.003916	-200...850°C {2}	10°C	0.1°C	0.1°C
Ni25...Ni1000	DIN 43760	-50...250°C {2}	10°C	0.1°C	0.1°C
Cu25...Cu1000	0.428 Ohm/°C	-50...200°C	10°C	0.1°C	0.1°C
B(PtRh30-Pt)	IEC 584	100...1820°C	50°C	2°C	0.1°C
C(W5-Re)	ASTM 988	0...2300°C	100°C	2°C	0.1°C
D(W3-Re)	ASTM 988	0...2300°C	100°C	2°C	0.1°C
E(NiCr-CuNi)	IEC 584	-270...900°C	50°C	1°C	0.1°C
J(Fe-CuNi)	IEC 584	-210...1200°C	50°C	1°C	0.1°C
K(NiCr-Ni)	IEC 584	-250...1370°C	50°C	1°C	0.1°C
L(Fe-CuNi)	DIN 43710	-200...900°C	50°C	1°C	0.1°C
N(NiCrSi-NiSi)	IEC 584	-200...1300°C	50°C	1°C	0.1°C
R(PtRh13-Pt)	IEC 584	-50...1750°C	100°C	2°C	0.1°C
S(PtRh10-Pt)	IEC 584	-50...1750°C	100°C	2°C	0.1°C
T(Cu-CuNi)	IEC 584	-250...400°C	40°C	1°C	0.1°C
U(Cu-CuNi)	DIN 43710	-200...600°C	50°C	1°C	0.1°C
Lin. voltage		-10...70 mV	2 mV	0.04 mV	0.1 mV
Lin. voltage		-0.1...1.1 V	20 mV	0.4 mV	1 mV
Lin. resistance		0...390 Ohm	5 Ohm	0.05 Ohm	0.01 Ohm
Lin. resistance		0...2200 Ohm	25 Ohm	0.25 Ohm	0.1 Ohm

{2} The max. temperature is lower for RTD-elements in the range 500...1000, i.e. Pt1000 max. 350°C.

Configuration

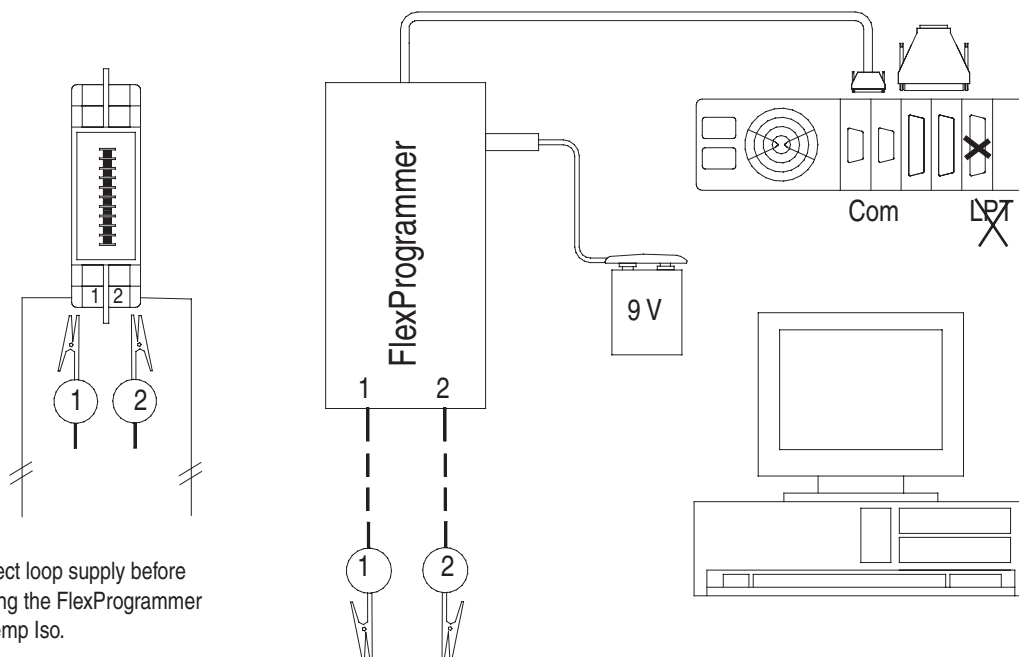

Ordering Details - FlexTemp Iso Temperature Transmitter

Type	82 2x-5xx
Standard version	4 digit
Demko EEx ia IIC T5, ATEX II 1G	3 4
Relay	6 digit
Without relay	2 3
With relay	3
Configuration	7 digit
Not configured	4
Configured according to customer specifications	5

Electrical Installation

RTD	T/C	Potentiometer	Resistance
-----	-----	---------------	------------

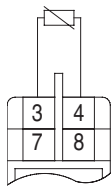

No cable-compensation {3}

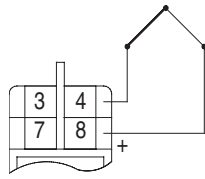

Internal CJC-compensation

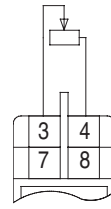

No compensation {3}

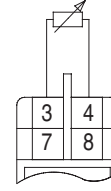

No compensation {3}

RTD	T/C	Potentiometer	Resistance
-----	-----	---------------	------------

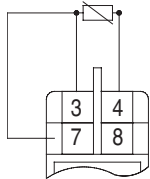

3-wire cable-compensation

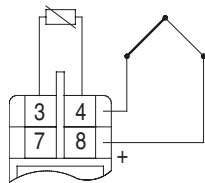

External CJC-compensation
No cable compensation {3}

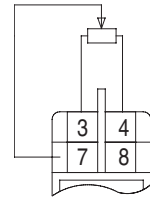

3-wire compensation for transfer resistance {4}

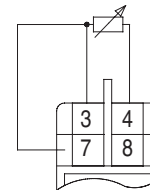

3-wire cable compensation

RTD	T/C	Potentiometer	Resistance
-----	-----	---------------	------------

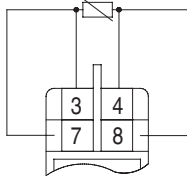

4-wire cable-compensation

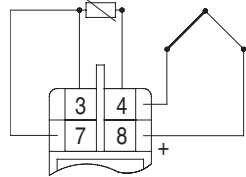

External CJC-compensation
3-wire cable compensation

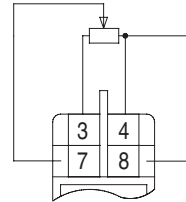

4-wire compensation for transfer resistance {4}

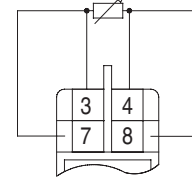

4-wire cable compensation

Current measurement	Voltage measurement	Notes
---------------------	---------------------	-------

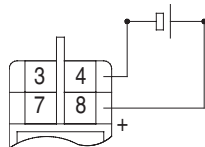
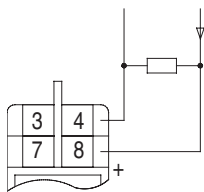

{3} Configurable compensation for cable resistance
{4} Transfer resistance between element and wiper

Accessories

FlexProgrammer configuration set, type number 82 23-903 comprises:
FlexProgrammer with 9 pole RS232C cable
3.5" Program diskettes
Battery plug
Cable with test plugs



Dimensional drawings

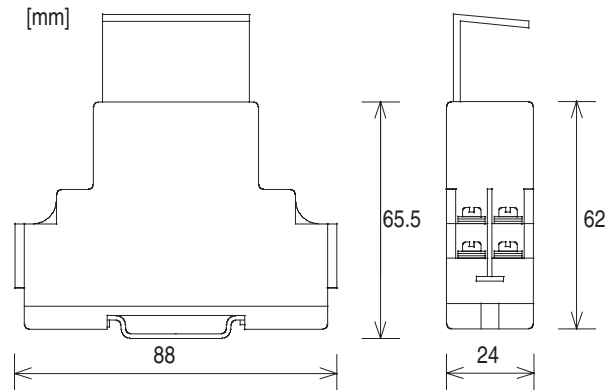

GB/2003-03-14 This data sheet may only be reproduced in full.